

SR70 (SR71 • 72 • 73 • 74) Series

Digital controller

Instruction Manual

Thank you for purchasing the Shimaden SR70 Series. Please check that the delivered product is the correct item you ordered. Please do not begin operating this product until you have read this instruction manual thoroughly and understand its contents.

"Notice"

Please ensure that this instruction manual is given to the final user of the instrument.

Preface

This instruction manual is meant for those who will be involved in the wiring, installation, operation and routine maintenance of the SR70 series (SR71, SR72, SR73 and SR74).

This manual describes the care, installation, wiring, function, and proper procedures for the operation of SR70 (SR71, SR72, SR73, SR74) series. Keep this manual at the work site during operation of the SR70 series. While using this instrument, you should always follow the guidance provided herein.

For matters regarding safety, potential damage to equipment and/or facilities, additional instructions are indicated by the following headings:

WARNING

Exercise extreme caution as indicated. This heading indicates hazardous conditions that could cause injury or death of personnel.

CAUTION

Exercise extreme caution as indicated. This heading indicates hazardous conditions that could cause damage to equipment and/or facilities.

NOTE

This heading indicates additional instructions and/or notes.

The mark  designates a protective conductor terminal. Make sure to properly ground it.

For matters regarding safety

⚠ WARNING

SR70 series controller is designed for controlling temperature, humidity and other physical subjects. It must not be used in any way that may adversely affect the safety, health or working conditions of those who come into contact with the effects of its usage. When used, adequate and effective safety countermeasures must be provided at all times. No warranty, express or implied, is valid in the case of using this product without the use of proper safety countermeasures correspondingly.

⚠ CAUTION

To avoid damage to the connected equipment, facilities or the product itself due to a fault of the product, safety countermeasure must be taken before usage, such as proper installation of the fuse and the overheating protection device. No warranty, express or implied, is valid in the case of usage without having implemented proper safety countermeasures.

⚠ CAUTION

- The **⚠** mark on the plate affixed to the instrument:
On the terminal nameplate affixed to the case of your instrument, the **⚠** mark is printed. This is to warn you of the risk of electrical shock which may result if the charger is touched while it is energized.
- A means to allow the power to be turned off, such as a switch or a breaker, should be installed in the external power circuit to be connected to the power terminal of the instrument.
Fix the switch or the breaker adjacently to the instrument in a position which allows it to be operated with ease, and with an indication that it is a means of turning the power off. The switch or the breaker should meet the requirements of IEC947.
- Fuse:
Since the instrument does not have a built-in fuse, do not forget to install a fuse in the power circuit to be connected to the power terminal.
The fuse should be positioned between the switch or the breaker and the instrument and be attached to the L side of the power terminal.
Fuse Rating: 250V AC 0.5A/medium lagged or lagged type
Use a fuse which meets the requirements of IEC127.
- Voltage/current of a load to be connected to the output terminal and the alarm terminal should be within a rated range.
Otherwise, the temperature will rise and reduce the life of the product and/or result in problems with the product.
For the rated voltage/current, see 7. Specifications on page 23.
The output terminal should be connected with a device which meets the requirements of IEC1010.
- A voltage/current different from that of the input specification should not be added on the input terminal. It may reduce the life of the product and/or result in problems with the product.
For the rated voltage/current, see 7. Specification on page 23.
For the rated voltage (mV or V) or current (4-20mA) input, the input terminal should be connected with a device which meets the requirements of IEC1010 as input terminals.
- As the CT input terminal for the heater break alarm (optional), only the attachment CT should be used. Using anything else may result in problems with the product.
For the CT provided, refer to 1-1. Check before Use on page 11.
- The SR70 series controller is provided with a draft hole for heat discharge. Take care to prevent metal or other foreign matter from obstructing it. Failure to do so may result in problems with the product and may even result in fire.
- Do not block the draft hole or allow dust or the like to adhere to it. Any rise in temperature or insulation failure may result in a shortening of the life of product and/or problems with the product. For spaces between installed instruments, refer to 2-4. External Dimensions and Panel Cutout on page 12.
- It should be noted that repeated tolerance tests against voltage, noise, surge, etc., may lead to deterioration of the instrument.
- Remodeling the instrument or using it in an anomalous way is prohibited.

Contents

	Page
1. Introduction.....	3
1-1. Check before use.....	3
1-2. Caution for use.....	3
2. Installation and wiring.....	3
2-1. Installation site (environmental conditions).....	3
2-2. Mounting.....	4
2-3. How to remove the instrument out of the case.....	4
2-4. External dimensions and panel cutout.....	4
2-5. Wiring.....	5
2-6. Terminal arrangement.....	5
2-7. Terminal arrangement table.....	5
3. Instruction for front panel.....	6
3-1. Drawing and the name of the parts.....	6
3-2. Instruction for front panel.....	6
4. Screen instruction.....	7
4-1. Power on and initial screen display.....	7
4-2. Screen change.....	7
4-3. Screen configuration.....	8
4-4. Instruction for screen change and each screen.....	9
4-5. Measuring range code table.....	10
4-6. Alarm type code table.....	10
5. Operation.....	10
5-1. Setting of set value (SV).....	10
5-2. AT (Auto tuning).....	11
5-3. Setting of alarm.....	12
6. Supplement.....	13
6-1. Auto return function.....	13
6-2. PID (Screen No.2,4 and 5 of mode 1 screen group).....	13
6-3. Control output characteristics.....	14
(Ⓞ digit of mode 2 screen)	
6-4. Error message.....	14
7. Specifications.....	15

1. Introduction

1-1. Check before use

This product has been fully checked for quality assurance prior to shipment. Nevertheless, you are requested to make sure that there is no error, damage or shortage of delivered items by confirming the model codes and checking the external view of the product and the number of accessories.

Confirmation of Model Codes:

Check the model codes stuck to the case of the product to ascertain if the respective codes designate what was specified when you ordered the product, referring to the following code table:

Item	Code and Description
1. Series	SR71, SR72, SR73, SR74
2. Input	8: Multi-input Thermocouple, R.T.D., Voltage (mV) 4: Current (mA) 6: Voltage (V)
3. Output	Y1: Contact I1: Current P1: SSR-drive voltage V1: Voltage
4. Optional function	0: None 1: Alarm 2: Alarm+Heater break alarm (30.0A) 3: Alarm+Heater break alarm (50.0A) 4: Set value bias 5: Alarm+Set value bias *6: Alarm+Heater break alarm (30.0A) + Set value bias *7: Alarm+Heater break alarm (50.0A) + Set value bias *Unselectable for SR71
5. Remarks	C: Without 9: With

Checking accessories:

- Instruction manual 1 set
- Unit decal 1 sheet
- Current transformer (CT) for heater break alarm: included with the heater break alarm option
 - TYPE CTL-6-S for 30A selection
 - TYPE CTL-12-S36-8 for 50A selection

NOTE: Contact our representative or our local office concerning any problems with the product, accessories or related items.

1-2. Caution for use

- (1) Avoid operating keys of the front panel with hard or sharp objects or motions. Lightly touch the operating keys with finger tip for operation.
- (2) Avoid using solvents such as thinner. Wipe gently with a dry cloth.

2. Installation and wiring

2-1. Installation site (environmental conditions)

⚠ CAUTION

In the case where there is an intention to operate this product at one of the following sites, be aware that the occurrence of fire and/or other dangerous situations is considerable. Exercise caution and avoid these places when selecting an operational site.

- (1) Where flammable gas, corrosive gas, oil mist and particles that can deteriorate electrical insulation are generated or are abundant.
- (2) Where the temperature is below -10°C or above 50°C
- (3) Where the relative humidity is 90%RH or below dew point.
- (4) Where highly intense vibration or impact is generated or transferred.
- (5) Near high voltage power lines or where inductive interference can affect the operation of the product.
- (6) Dew drops or direct exposure to sun light.
- (7) Where the elevation is in excess of 2,000m.

NOTE: The environmental conditions belong to the installation category II of IEC 664 and the degree of pollution is 2.

2-2. Mounting

- (1) Machine the mounting hole by referring to panel cutout in section 2-4.
- (2) Applicable thickness of the mounting panel is from 1.0 to 3.5mm.
- (3) As this product provides mounting fixture, insert the product from the front panel for installation.

2-3. How to remove the instrument out of the case

⚠ CAUTION

When the instrument is removed/replaced in the case, make sure the power is off. If it is done while the power is on, it may lead to problems with the product and/or other problems.

There is no need to remove your SR70 series controller out of the case. Nevertheless, should the need arise, for example, for replacement, follow the steps described below:

Insert a minius screwdriver of 6mm-9mm into the opening (where packing is exposed) of the front case and rotate the screwdriver while pushing up the lock lever behind the packing. Once the instrument comes out by a few millimeters, you can remove it by hand.

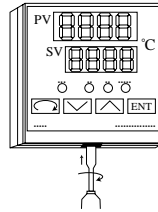

2-4. External dimensions and panel cutout

SR71 External dimensions (unit: mm)

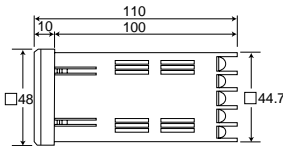

SR71 Panel cutout (unit: mm)

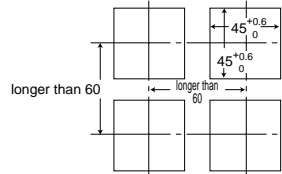

SR72 External dimensions (unit: mm)

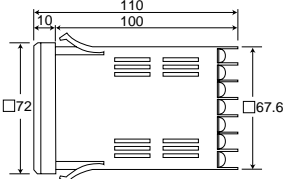

SR72 Panel cutout (unit: mm)

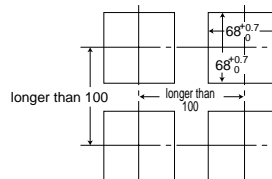

SR73 External dimensions (unit: mm)

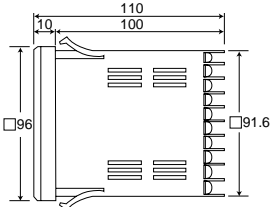

SR73 Panel cutout (unit: mm)

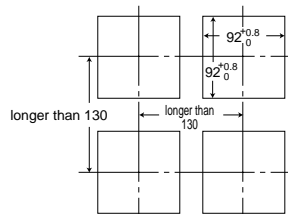

SR74 External dimensions (unit: mm)

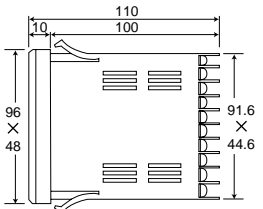

SR74 Panel cutout (unit: mm)

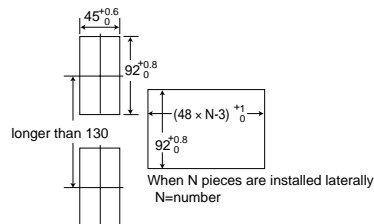

Dimension of current transformer (CT) for heater break alarm

30A (CTL-6-S) (unit: mm)

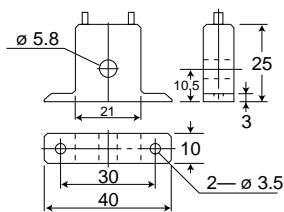

50A (CTL-12-S36-8) (unit: mm)

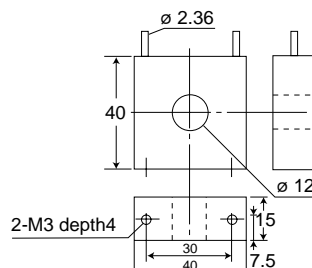

2-5. Wiring

⚠ WARNING

- Always disconnect this product from any power source during wiring operation to prevent electrical shock.
- Be certain that the protective conductor terminal (⊕) is properly grounded. Otherwise, a serious electric shock may result.
- Avoid touching the wired terminal and charged devices while supplying power.

- (1) Wiring operation should be done according to the instruction for the terminal arrangement in section 2-6. Exercise care that no wrong connection is made.
- (2) Crimp terminal should accommodate the M3.5 screw and should have a width of less than 7mm.
- (3) For thermocouple input, select the compensation wire suitable to the thermocouple type.
- (4) For R.T.D. input, leads should be less than 5 Ω in resistance and three leads should have the same resistance.
- (5) Input signal line should be conducted safety apart from the high voltage power line.
- (6) Shield wiring (single point grounding) is effective for static induction noise.
- (7) Short interval twisted pair wire for input signal is effective for electromagnetic induction noise.
- (8) When wiring, use wire (1mm² minimum in sectional area) of 600V Grade Polyvinyl Chloride insulated Wire or equivalent wire which has the same ratings.
- (9) Earth grounding should be performed with earth resistance less than 100 Ω and with wire thicker than 2mm².
- (10) Noise filter

In case where the instruments are affected by the power supply noise, use a noise filter for preventing malfunction.

Noise filter should be mounted on the grounded panel, the shorted wire should be used to connect between the noise filter output and the power line terminal.

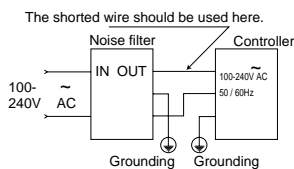

Recommendable noise filter: TDK ZMB2203-13

2-6. Terminal arrangement

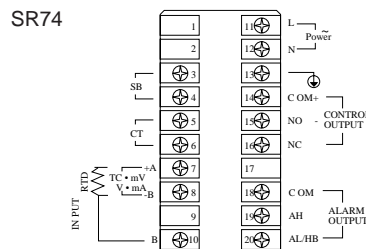
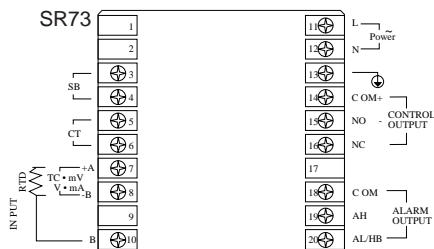
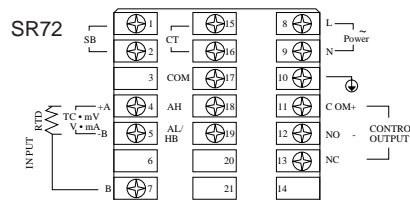
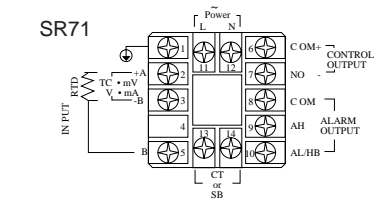

2-7. Terminal arrangement table

Name of terminal and description	Terminal number		
	SR71	SR72	SR73 • 74
Power terminal 100-240V AC±10% 50/60Hz 11VA	11 - 12	8 - 9	11 - 12
Protective conductor terminal (⊕)	1	10	13
Input terminal R.T.D.A, Thermocouple, Voltage, Current+	2	4	7
Input terminal R.T.D.B, Thermocouple, Voltage, Current-	3	5	8
	5	7	10
Output terminal Contact COM, SSR Drive voltage, Voltage, Current+	6	11	14
Contact NO, SSR Drive voltage, Voltage, Current-	7	12	15
Contact NC		13	16
Alarm output (option) terminal			
COM Contact rating 240V AC 1.5A (resistive load)	8	17	18
AH Higher limit alarm	9	18	19
AL/HB Lower limit alarm or heater break alarm	10	19	20
Heater break alarm (option) CT input terminal	13 - 14	15 - 16	5 - 6
Set value bias (option) input terminal	13 - 14	1 - 2	3 - 4

NOTE: For SR71, input terminal of heater break and set value bias is common. Start operation after checking the additional function.

For Thermocouple, Voltage, and Current input, measurement error results by connection between B and B terminal.

3. Instruction for front panel

3-1. Drawing and the name of the parts

This is an example of the front panel of SR71.

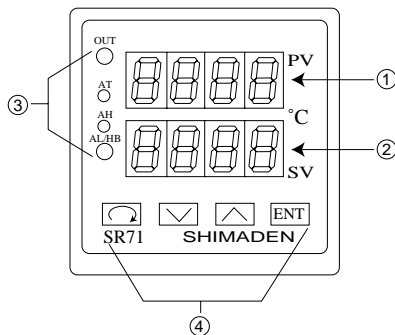

Name of parts

- ①: Measured value (PV) display
- ②: Set value (SV) display
- ③: Monitor LED
- ④: Key switches

3-2. Instruction for front panel

①: Measured value (PV) display (green)

- (1) Displays current measured value on the mode 0 basic screen.
- (2) Displays parameter type on each parameter screen.

②: Set value (SV) display (orange)

- (1) Displays set value on the mode 0 basic screen.
- (2) Displays selected item and set value on each parameter screen.

③: Monitor LED

(1) OUT (output) monitor LED (green)

- For contact or SSR drive voltage output, a light turns on for output ON and turns off for output OFF.
- For current or voltage output, the light intensity changes proportionally to the output altitude.

(2) AT (auto tuning) monitor LED (green)

On selection by , , turns on AT waiting (key), flashes on AT execution.

(3) AH alarm output monitor LED (red)

Turns on for higher limit alarm output ON.

(4) AL/HB alarm output monitor LED (red)

Turns on for lower alarm output ON or heater break alarm ON.

④: Key switches

(1) (parameter) key

- Press on set screen of mode 0 screen group and mode 1 screen group to move to next set screen.
- Keep pressing three (3) seconds for function of move key between basic screen of the mode 0 screen group and direct call screen of mode 1 screen group.

(2) (down) key

- Press on the set screen to flash the point of the least digit and to reduce data or back increment data.

(3) (up) key

- Press on the set screen to flash the point of the least digit and to increase data or increment data.

(4) (entry/registration) key

- Press on the set screen of the mode 0 screen group and mode 1 screen group to fix the data changed by the keys and to extinguish flash of the point.
- Press on the mode 2 screen to fix the data of the point flashing digit and simultaneously to move the data changing digit (point flashing digit).
- Press for five (5) seconds for function of move key between the basic screen of mode 0 screen group and the mode 2 screen.

4. Screen instruction

4-1. Power on and initial screen display

After turning on power, the display shows each power on initial screen for approx. 1.5 seconds, then moves into the basic screen of the mode 0 screen group.

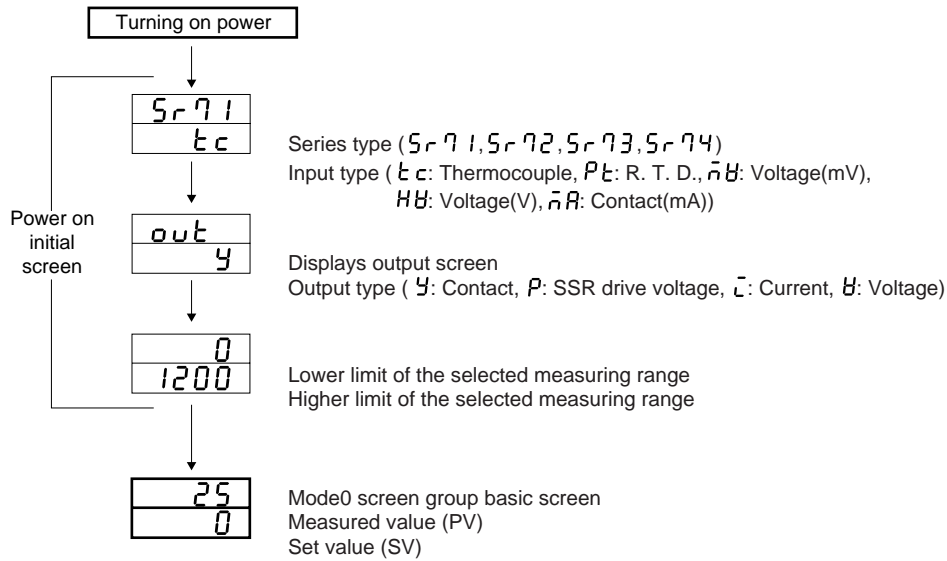

4-2. Screen change

(1) Screen change from mode 0 group to mode 1 group

- Keep pressing the key for three (3) seconds on basic screen of the mode 0 screen group to change screen into direct call screen of mode 1 screen group. Keep pressing the key for three (3) seconds on direct call screen of mode 1 screen group to change screen into basic screen of the mode 0 screen group.

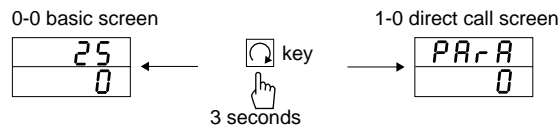

NOTE: In the above, the mark indicates that the key above the mark is pressed. The same applies hereinafter.

(2) Screen change from mode 0 group to mode 2 screen

- Keep pressing key for five (5) seconds on basic screen of the mode 0 screen group to change the screen into mode 2 screen. Keep pressing key for five (5) seconds on the mode 2 screen to change screen into basic screen of the mode 0 screen group.

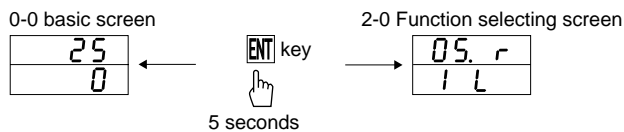

(3) Screen change within mode 0 screen group

- By pressing the key, the screen changes.
- Without alarm option and with ON-OFF action, only basic screen is displayed and no screen change is performed by pressing the key.

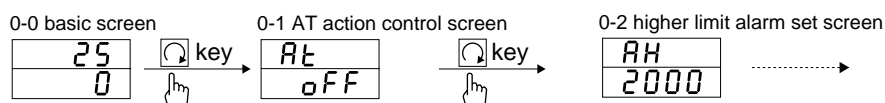



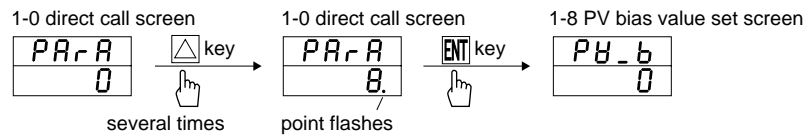

(4) Screen change within mode 1 screen group

- Two methods are used for screen change within mode 1 screen group.
- One is to press the  key as shown on above mode 0 screen group.
- The other is to mode the screen directly by indicating screen No. on the top direct call screen.

Example: Direct calling the screen No.8 PV bias value set screen





(5) Selecting and setting digit to change of mode 2 screen

- When mode 2 screen is displayed, the point of selectable digit flashes.
- By pressing  key, the selectable digit (digit whose point is flashing) moves.
- In case of changing the set value, flash the point to be changed with  key, select data with the   keys and press  key again to register the set value and move selectable digit.

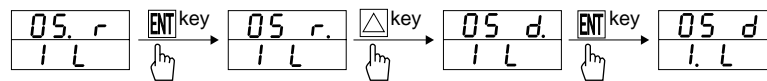









Example: changing the control output characteristics from *r* (heating) to *d* (cooling)



* "." on the screen shows the selectable digit (digit whose point is flashing).

NOTE: In case of changing data and pressing  key longer than 5 seconds, the screen moves to mode 0 basic screen without a data registration. It requires a data verification with  key and screen change.

(6) Shifting setting items on input scaling screen of mode 2 screen group and setting method

- Pressing the  key on the function selecting screen calls the input scaling screen onto the display. The decimal point in the rightmost position on the top row flashes.
- Press the  or  key to change the lower limit value and press the  key to register the data.
- Upon registering the lower limit value data, the decimal point in the rightmost digit in the bottom row begins to flash. Change the higher limit value by pressing the  or  key and register it by means of the  key.
- Upon registering the higher limit value data, the decimal points in the rightmost digits of the bottom and top rows flash. Change the positions of the decimal points by pressing the  or  key and register it by means of the  key.
- Each time the  key is pressed, the flashing decimal point in the rightmost digit moves from the top row → bottom row → top and bottom rows → top row →.
- In case the lower limit value and the higher limit value are set to produce a difference which is less than 10 counts or more than 5000 counts, the higher limit value is forced to change to +10 or +5000 counts. The higher limit cannot be set to be less than a lower limit value +10 counts or more than a lower limit value +5000 counts.

4-3. Screen configuration

In the SR70 series controller, the screen configuration is divided into screen groups and screens corresponding to the frequency of usage in their operation.

(1) Mode 0 screen group

It is made up of screens of relatively high frequency in use for operation, i.e., the basic screen (for setting target value and confirming current measured value), the auto tuning action control screen and the alarm setting screens.

(2) Mode 1 screen group

Made up of screens of less frequency than those of mode 0 group, i.e., screens for setting values to be changed as required by input conditions or control capability and a screen for locking items not to be changed.

(3) Mode 2 screen (function selecting screen)

Once items are set in this screen, the need to change them seldom arises; selected code of measuring range, selected output characteristic, selected type of optional alarm functions, and selected action mode of heater break alarm are displayed on this single screen.

(4) Method of changing data

Press the  or  key to change data in each screen and press the  key to register the changed data.

4-4. Instruction for screen change and each screen

Mode 0 screen group

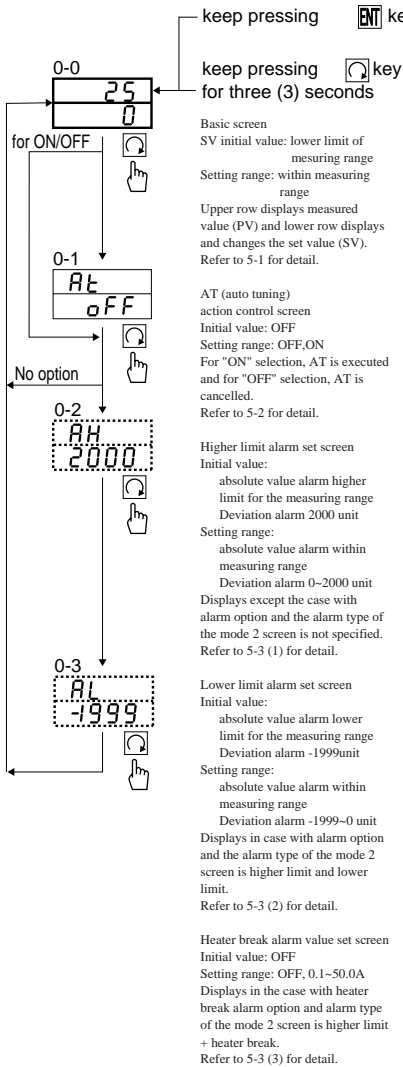

keep pressing **ENT** key for five (5) seconds

Mode 1 screen group

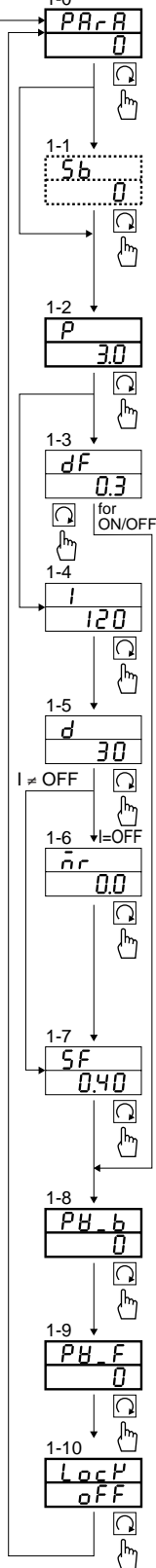

Direct call screen (screen No.0)
Initial value: 0
Setting range: 0~12

Set the screen No. to move the screen of the mode screen group. Refer to 4-2 (4) for detail. The screen with no display condition is skipped.

Set value bias set screen (screen No.1)
Initial value: 0
Setting range: -1999~2000 unit

Displays in the case with set value bias option. The set value is effective during shorted SB terminal, and is added to or subtracted from the set value. The point of the least digit of the lower row turns on while this function is effective.

Proportional band set screen (screen No.2)
Initial value: 3.0%
Setting range: OFF, 0.1~999.9%

Not required in case of auto tuning. Refer to 6-2 (1) for proportional band. Select "OFF" to perform ON/OFF (two position) action.

Action hysteresis set screen (screen No.3)
Initial value: 3 or 0.3
Setting range: 1~999 unit

Set ON/OFF hysteresis on ON/OFF action. Not displayed on PID action.

Integral time set screen (screen No.4)
Initial value: 120 seconds
Setting range: OFF, 1~6000 seconds

Not required for auto tuning. Refer to 6-2 (2) for integral time. Not shown on ON/OFF action.

Derivative time set screen (screen No.5)
Initial value: 30 seconds
Setting range: OFF, 1~3600 seconds

Refer to 6-2 (3) for derivative time. Not shown on ON/OFF action.

Manual reset value setting screen (screen No.6)
Initial value: 0.0%
Setting range: -50.0~+50.0%
Offset is adjusted when I=OFF (P or PD action) is selected. This screen appears only when I=OFF has selected. Manual Reset Value
In the PID operation, an offset is corrected automatically by I.e., integral calculation. When it is set at OFF, this correction is not made and output is manually increased or decreased for correction. This is called manual reset (MR).

Set value function set screen (screen No.7)
Initial value: 0.40
Setting range: OFF, 0.01~1.00

Used for suppressing overshooting and undershooting in expert PID. For SF=1.00 minimize overshooting, for SF=OFF, expert PID is unable to be normal PID action. Not shown on ON/OFF action.

PV bias value set screen (screen No.8)
Initial value: 0 or 0.0
Setting range: -200~200 unit

Used for sensor input error compensation. Controlling is performed with corrected value for bias setting.

PV filter time set screen (screen No.9)
Initial value: 0 second
Setting range: 0~100 seconds

Used for the case of large input change and noise overlapping to reduce the effect.

Key lock mode set screen (screen No.10)
Initial value: OFF
Setting range: OFF, 1,2,3

Lock the item not to be changed. No data change is effective on the display screen locked.

Following table shows the lock No. and screen range locked.

Mode 2 screen group

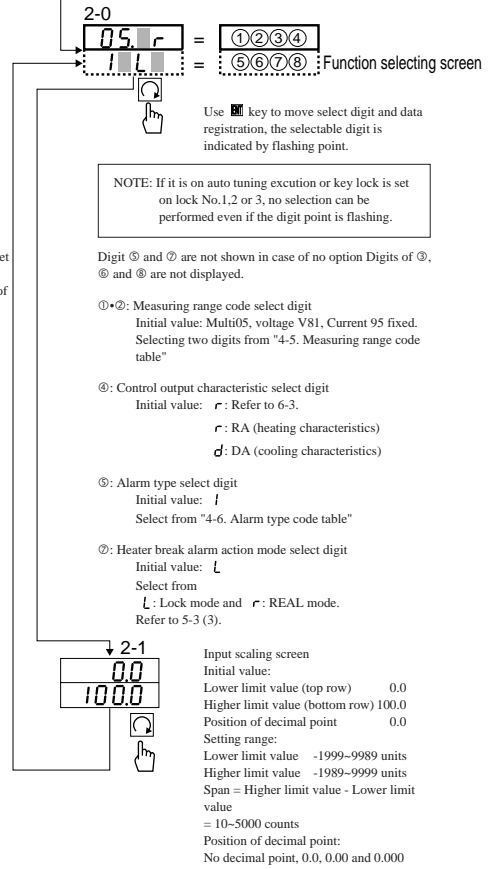

Scaling is done for linear input (mV, V or mA). The screen is only for monitoring and no setting is possible in the case of sensor input. Refer to Item 4-2 (6) for details.

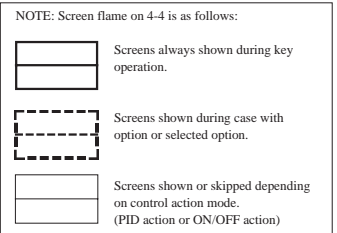

Upper row displays load current detected by CT. (If the output is OFF, it shows **h---**)

NOTE: The heater break alarm can be added if the instrument has alarm option and the control output is the contact type or the SSR drive voltage type.

Heater break alarm

- Set the alarm level at approx. 85% of the normal load current. In case of large current variation, set larger value. If multiple heaters are connected in parallel, set a larger value to output alarm for single heater break.
- If "OFF" is selected, no alarm output is obtained. Selecting "OFF" during alarm output, the alarm output is canceled.
- For case when heater break function is not applicable to direct current load, phase controlling current and three phase heater.
- Connecting current transformer (CT)
One of the load line wires passes through the hole of the custom CT.
Wire from the secondary side terminal of CT to the CT input terminal of the instrument.

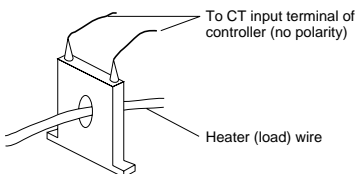

NOTE: Two types of the heater break CT of 30A and 50A are available, the type selected upon ordering is shipped with the product as an accessory. Note the maximum current to be set is 50.0A for both types.

Lock No.	Screen range locked
OFF	Unlock (all data change enabled)
1	Basic screen, Key lock for screens except AT action control screen
2	Key lock for screens except basic screen.
3	All key lock

4-5. Measuring range code table

Input type		Code	Measuring range (°C)	Code	Measuring range (°F)
Multi input	Thermocouple	*1B	0 ~ 1800	12	0 ~ 3300
		R	0 ~ 1700	13	0 ~ 3100
		S	0 ~ 1700	14	0 ~ 3100
		K	-100 ~ 400	15	-150 ~ 750
		K	0 ~ 1200	16	0 ~ 2200
		E	0 ~ 700	17	0 ~ 1300
		J	0 ~ 600	18	0 ~ 1100
		T	-199.9 ~ 200.0	19	-300 ~ 400
		N	0 ~ 1300	20	0 ~ 2300
		*2U	-199.9 ~ 200.0	21	-300 ~ 400
		*2L	0 ~ 600	22	0 ~ 1100
R.T.D.	Pt100	31	-200 ~ 600	39	-300 ~ 1100
		32	-100.0 ~ 100.0	40	-150.0 ~ 200.0
		33	-50.0 ~ 50.0	41	-50.0 ~ 120.0
		34	0.0 ~ 200.0	42	0 ~ 400
	JPt100	35	-200 ~ 600	43	-300 ~ 1100
		36	-100.0 ~ 100.0	44	-150.0 ~ 200.0
		37	-50.0 ~ 50.0	45	-50.0 ~ 120.0
		38	0.0 ~ 200.0	46	0 ~ 400
Voltage mV	0-10	71	Initial value: 0.0 ~ 100.0 Conditions of scaling Scaling setting range: -1999~9999, Span: 10~5000 counts Position of decimal point: No decimal point, the first second and third decimal places	*1 Thermocouple B: Accuracy not guaranteed for temperatures below 400°C (750°F). *2 Thermocouple U.L: DIN43710 Thermocouple B,R,S,K,E,J,T,N: JIS/ANSI/IEC R.T.D.Pt100: Present JIS/IEC JPt100: FormerJIS	
	10-50	72			
	0-100	73			
Voltage V	0-1	81			
	1-5	82			
	0-10	83			
Current 4-20mA		95			

NOTE: In case measuring range is modified, set values, alarm action point and other related values are all initialized.

4-6. Alarm type code table

Alarm code	AH assignment	With/Without inhibit action	AL/HB assignment	With/Without inhibit action
0 (0)	Not assigned	—	Not assigned	—
1 (1)	Higher limit deviation value	Without inhibit action	Lower limit deviation value	Without inhibit action
2 (2)	Higher limit absolute value	Without inhibit action	Lower limit absolute value	Without inhibit action
3 (3)	Higher limit deviation value	With inhibit action	Lower limit deviation value	With inhibit action
4 (4)	Higher limit absolute value	With inhibit action	Lower limit absolute value	With inhibit action
5 (5)	Higher limit deviation value	Without inhibit action	Heater break	—
6 (6)	Higher limit absolute value	Without inhibit action	Heater break	—
7 (7)	Higher limit deviation value	With inhibit action	Heater break	—
8 (8)	Higher limit absolute value	With inhibit action	Heater break	—

NOTE: The inhibit action on the alarm type code table above is the action which outputs alarm when the measured value enters alarming range again after inhibiting alarm output for the value within the alarming range and allows it out of the range once.

NOTE: In case types of Alarms are changed, values are initialized.

5. Operation

5-1. Setting of set value (SV)

- (1) Set value setting is performed on basic screen of the mode 0 screen group.
- (2) Press the Δ or ∇ key to set set value. Keep pressing it to flash the point of the least digit of set value and increase (or decrease) value.
- (3) After confirming the value to coincide the set value, press ENT to register the data.
- (4) After registration of the data, the point of the least digit goes off.

Example: Setting set value to 500°C

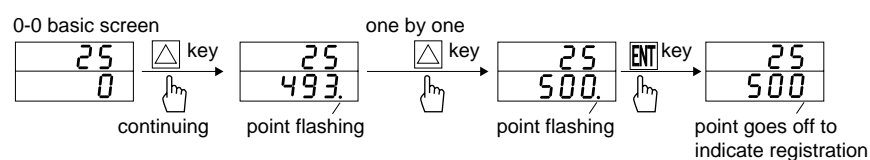

5-2. AT (Auto tuning)

(1) Execution of AT action

- Auto tuning function is prepared for suitable control by using PID control action with constants of P: proportional band, I: integral time and D: derivative time calculated for PID control which are automatically stored in the internal memory.
- By pressing the Δ or ∇ key AT action control screen, **OFF** display on lower row turns into **ON** and the point of the least digit starts flashing, then the LED for AT monitoring turns on to indicate AT standby. Press **ENT** key to start AT action with point going off and LED for AT monitoring flashing.

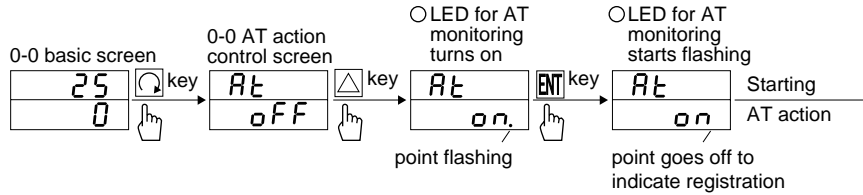

- During AT execution, PID constants are defined by calculation for ON/OFF action (100%/0%) output for the measuring value increase and decrease around the set value and store internal memory. Control action according to stored PID constant is started. Then the LED for AT monitoring goes off and the display on the AT action control screen is changed to **OFF**.

(2) Abort of AT

To abort the AT action, by showing the AT action control screen, press the ∇ or Δ key to select **OFF** and press **ENT** key to abort AT and LED for AT monitoring also goes off.

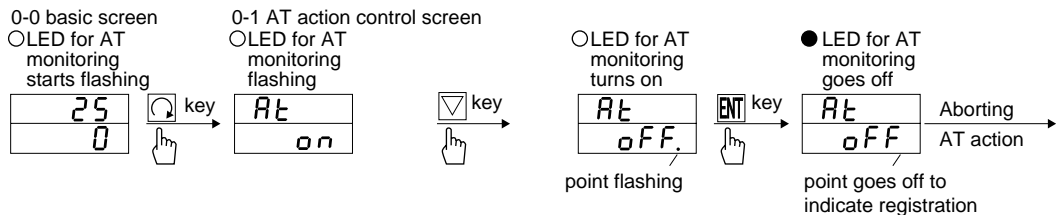

NOTE: When the AT action is aborted, each value for PID is not changed.

(3) AT unable for following conditions.

- The proportional band is "OFF" setting (ON/OFF action). (No AT screen is shown.)
- Lock No.2 or 3 is selected on the key lock set screen.
- PV (measured) value is over the scale.

(4) AT is automatically canceled in the following condition during AT execution.

- Duration equal to or longer than 2 hours passed in the output level of 0% or 100%.
- Power shutdown.
- PV (measured) value is over the scale during AT execution.

(5) Starting AT (selecting "ON" on the selection screen) during AT execution, no AT is performed and continues running AT execution.

(6) The items enable to be set are as follows:







- Level setting of the higher limit alarm.
- Level setting of the lower limit alarm or heater break alarm.
- Screen number setting on the direct call screen of mode 1 screen group.

(7) Relationship between AT and set value bias is as follows:

- When SB terminal is shorted before AT execution, AT executes in the condition with SV + set value bias.
- When SB terminal is opened during AT execution mentioned in the above, AT executes with SV + set value bias condition, then controlled with SV condition after completing AT execution.
- When SB terminal is opened, AT executes with SV condition.
- When SB terminal is shorted during AT execution mentioned in the above, AT executes with SV condition, then controlled with SV + set value bias condition after completing AT execution.

5-3. Setting of alarm

(1) Higher limit alarm setting

- The higher limit alarm set screen is shown in case where alarm option is added and the higher limit alarm of the alarm type select digit on mode 2 screen is selected.
- Higher limit deviation value alarm is output for measured value to be greater than set value + alarm set value.
- For higher limit deviation value alarm, if set value + alarm set value exceeds the higher limit of the measuring range, the action point is the higher limit of the measuring range.
- Higher limit absolute value alarm outputs alarm signal for the measured value exceeds the alarm set value.
- Higher limit absolute value alarm is set on any value within the measuring range.
- Higher limit alarm set screen is shown by pressing the  key on AT action control screen.
- With the  or  key, value at which the alarm signal should be output is selected and registered with  key.
- Operation of the  or  key is identical with set value setting.



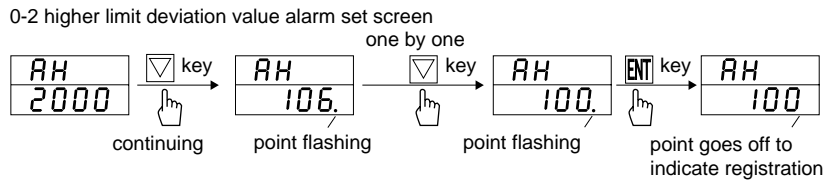

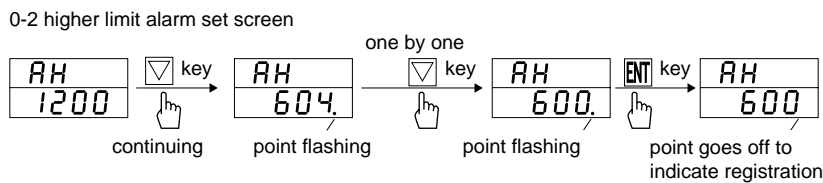

Example 1: In case of setting the alarm action point at 600°C for higher limit deviation value alarm. Set value is 500°C.
As $500^{\circ}\text{C} + \text{X}^{\circ}\text{C} = 600^{\circ}\text{C}$, $\text{X} = 600 - 500 = 100^{\circ}\text{C}$ should be set.



Example 2: In case of setting the alarm action point at 600°C for higher limit absolute value alarm, the set point is action point.



(2) Lower limit alarm setting

- The lower limit alarm set screen is shown in case where alarm option is added and the lower limit alarm of the alarm type select digit on mode 2 screen is selected.
- Lower limit deviation value alarm is output for measured value to be less than set value + (alarm set value).
- For lower limit deviation value alarm, if set value + (alarm set value) is less than the lower limit of the measuring range, the action point is lower limit of the measuring range.
- Lower limit absolute value alarm outputs alarm signal for the measured value is less than the alarm set value.
- Lower limit absolute value alarm is set on any value within the measuring range.
- Lower limit alarm set screen is shown by pressing the  key on higher limit alarm set screen.
- With the  or  key, value at which the alarm signal should be output is selected and registered with  key.
- Operation of the  or  key is identical with higher limit alarm setting.



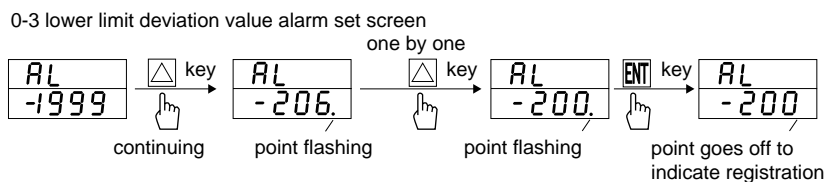

Example 1: In case of setting the alarm action point at 300°C for lower limit deviation value alarm, set value is 500°C.
As $500^{\circ}\text{C} + (\text{X}^{\circ}\text{C}) = 300^{\circ}\text{C}$, $\text{X} = 300 - 500 = -200^{\circ}\text{C}$ should be set.

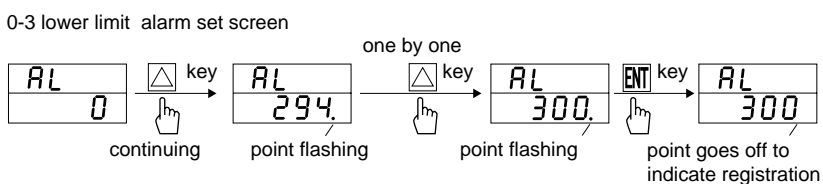

Example 2: In case of setting the alarm action point at 300°C for lower limit absolute value alarm, the set point is action point.



(3) Heater break alarm setting

- The heater break alarm set screen is shown in case where heater break alarm option is added and heater break alarm of the alarm type select digit on mode 2 screen is selected.
- Displayed by pressing the  key on higher limit alarm set screen, upper row shows the real time current value and lower row shows alarm action current set value.
- Break alarm value can be selected from OFF and range of 0.1~50.0A, heater break alarm is disabled by selecting OFF.
- By setting OFF during heater break alarm signal output, heater break alarm output is terminated.
- For set value other than OFF, heater break alarm signal is output if the current that flows in case where control output (contact or SSR drive voltage) is ON, is less than set value.
- If LOCK mode is selected at heater break alarm action mode select digit on mode 2 screen and the break alarm signal is output, alarm signal is only terminated by changing the break alarm value into OFF or shutting down power.
If REAL mode is selected and heater current is less than current value being set, break alarm signal is generated. If heater current exceeds the current threshold (0.1A), output of break alarm is terminated.
- With the  or  key, value at which heater break alarm signal should be output is set and registered with  key.

Example: In case of setting heater break alarm action point at 25.0A.

0-4 heater break alarm set screen

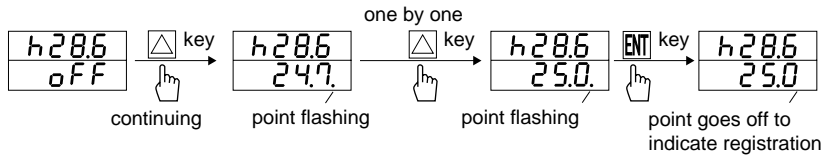

6. Supplement

6-1. Auto return function

When no key action is made for longer than three (3) minutes on each screen except heater break alarm value set screen, the screen moves back to the basic screen of the mode 0 screen group (auto return).

6-2. PID (Screen No.2,4 and 5 of mode 1 screen group)

PID values are automatically set by performing auto tuning, modification may be required for object to be controlled. If auto tuning is not performed, PID values should be set. Description for PID is as follows:

(1) P (proportional action)

Control output rate (%) is set for measuring range.

Control output value changes in proportion with measured value (PV) and set value (SV).

For wide proportional band, change of control output is small relative to deviation. The narrower the proportional band is, the larger the output variation is and the more intense proportional action is. Too narrow proportional band causes ON-OFF like action with oscillation (hunting). By setting P to be OFF, ON-OFF action is performed.

(2) I (integral time)

A function that compensates the offset created by proportional action. Effect of compensation is weaker for longer integral time and is intensified by shortening time. Too short integral time causes integrating hunting and may result in wavy operation.

(3) D (derivative time)

Improves stability of control by reducing overshooting of integration from expected change of the control output. Effect of compensation is weaker for shorter derivative time and is intensified for longer time. Too long derivative time may result in oscillating operation.

6-3. Control output characteristics (④ digit of mode 2 screen)

Control output characteristics determines the control output direction according to the measured value (PV) relative to the set value (SV).

(1) **r** (RA characteristics)

Control out put increases for lower measured value relative to set value, it is used for heating on temperature control.

(2) **d** (DA characteristics)

Control output decreases for lower measured value relative to set value, it is used for cooling on temperature control.

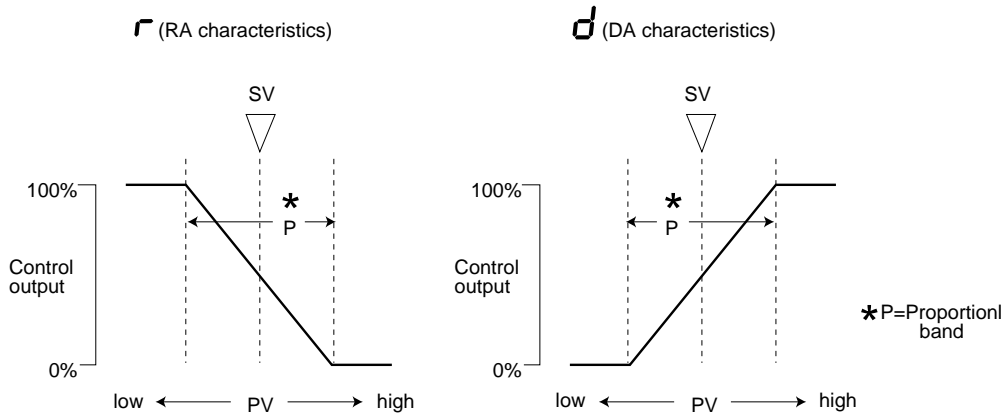

6-4. Error message

The following error messages are shown on the PV display screen in case of defect.

(1) Defect of measuring input

- HHHH** In case of thermocouple break, R.T.D.A break and PV being approx. 10% greater than higher limit of measuring range.
- LLLL** In case of PV being approx. 10% less than the lower limit of measuring range with inverted polarity of input wiring.
- CJHH** Cold junction (CJ) defect to higher side for thermocouple input.
- CJLL** Cold junction (CJ) defect to lower side for thermocouple input.
- b---** Break of B or B and multiple break of A, B, B upon R.T.D. input

(2) Defect of heater break alarm CT

- HbHH** CT input value is greater than 55A.
- HbLL** CT input value is less than -5A.

NOTE: Message of heater break alarm is only displayed on heater break alarm set screen.

h--- is shown when output is OFF. It is not defective.

NOTE: Contact to us or our representative in case of any defect regarding this product.

7. Specifications

Display

- Digital display : Measured value (PV) /7-segment green LED 4 digits
: Set value (SV) /7-segment orange LED 4 digits
- Parameter display : 7-segment LED for PV and SV
- Action display : Green LED for two points of output (OUT) and auto tuning (AT)
: Red LED for two points of alarm (AH,AL/HB)
- Display accuracy : $\pm(0.5\% \text{ FS}+1 \text{ digit})$ excluding cold junction temperature compensation accuracy in the case of the thermocouple input.
: $\pm 5\% \text{ FS}$ for temperatures below 400°C (750°F) of thermocouple B.
- Display accuracy range : $23\pm 5^{\circ}\text{C}$ ($18\sim 28^{\circ}\text{C}$)
- Display resolution : Depends on measuring range (0.1, 1)
- Measured display range : $-10\sim 110\%$ ($-210\sim 680^{\circ}\text{C}$ for $-200\sim 600^{\circ}\text{C}$ of R.T.D. input)
- Sampling cycle : 0.5 sec.

Setting

- Setting : By 4 front key switches
- Setting range : Same as measuring range

Input

- Type of input : Multiple input of Thermocouple, R.T.D., Voltage (mV), or Voltage (V), or Current 4~20mA DC by code selection.
- Thermocouple : B, R, S, K, E, J, T, N, {U,L (DIN 43710)} Refer to Measuring range code table.
- External resistance : 100 Ω max.
- Input impedance : 500k Ω min.
- Burnout : Standard feature (up scale)
- Cold junction temperature compensation accuracy : $\pm 2^{\circ}\text{C}$ ($^{\circ}\text{F}$) ($5\sim 45^{\circ}\text{C}$)
: $\pm 5^{\circ}\text{C}$ to the negative side of measuring range in case of T and U input, though.
- R.T.D. : JIS Pt100/Jpt100 3-wire type
- Amperage : Approx. 0.25mA
- Lead wire tolerable resistance : 5 Ω max./wire (The 3 lead wires should have same resistance.)
- Voltage : 0~10, 10~50, 0~100mV DC or 0~1, 1~5, 0~10V DC
- Input impedance : 500k Ω min.
- Current : 4~20mA DC
- Receiving impedance : 250 Ω
- Input scaling function : Scaling possible for voltage (mV, V) or current (mA) input.
- Scaling range : -1999~9999 counts.
- Span : 10~5000 counts
- Position of decimal point : None, 0.0, 0.00, 0.000
- Sampling cycle : 0.5 sec.
- PV bias range : ± 20.0 unit in case the decimal point is included in the measuring range. If not, ± 200 unit.
- PV filter : 0~100 sec. (0=without filter)
- Isolation : Insulated between input and output (not insulated between input and system, SV bias and CT input)

Control

- Control mode : Auto tuning PID
- Proportional band (P) : Off, 0.1~999.9% FS (Off setting: On-Off action)
- Integral time (I) : Off, 1~6000 sec. (Off setting: P or PD action)
- Derivative time (D) : Off, 1~3600 sec. (Off setting: P or PI action)
- Manual reset (MR) : -50.0~50.0% (Valid when P=OFF and I=OFF)
- On-Off hysteresis : 1~999 unit
- Proportional cycle : Fixed to 20 sec. during contact output
Fixed to 2 sec. during SSR drive voltage output
- Control output characteristics : RA/DA selectable (set to RA when shipped)
- Set value function (SF) : Off (Off=0.00) and 0.01~1.00

Control output type/rating

- Contact output SR71 : 240V AC 2.0A/resistive load: 1.2A/inductive load
SR72, SR73 and SR74 : 240V AC 2.5A/resistive load: 1.5A/inductive load
- Current output : 4~20mA DC/load resistance: 60 Ω max.
- SSR drive voltage output : $15\pm 3\text{V}$ DC (with load resistance at 1.5k Ω)/load current: 20mA max.
- Voltage output : 0~10V DC/load current: 2mA max.
- Isolation : Isolation between control output and system and input

Alarm Output (option)

- Number of alarm points : 2 (AH and AL/HB) (for both normal open and common)
- Alarm Type : Selectable from combinations of the following 9 types
0. Not assigned
1. Higher limit deviation value + lower limit deviation value without inhibit action
2. Higher limit absolute value + lower limit absolute value without inhibit action
3. Higher limit deviation value + lower limit deviation value with inhibit action
4. Higher limit absolute value + lower limit absolute value with inhibit action
5. Higher limit deviation value without inhibit action + heater break
6. Higher limit absolute value without inhibit action + heater break
7. Higher limit deviation value with inhibit action + heater break
8. Higher limit absolute value with inhibit action + heater break

- Alarm setting range : Higher limit and lower limit absolute value alarms: Within full scale of measuring range
- Deviation value : Higher limit: 0~2000 unit
: Lower limit: -1999~0 unit
In case SV is out of the measuring range, higher and lower limit values of the measuring range become the action points.
- Alarm action : On-Off action
- Alarm action hysteresis : Fixed to 0.2% of the measuring range
- Alarm output/rating : Contact 1a (common)/240V AV 1.5A (resistive load)

Heater Break Alarm (option)

This function can be added if the instrument has an alarm option and the control output is the contact type or the SSR drive voltage type. In SR71, addition is possible unless it has an SV bias option.

- Alarm action : Heater amperage detected by externally attached CT. Alarm output
On upon detection of heater break while control output is On.
- Current setting range : Off, 0.1~50.0A (Alarm action stops when Off is set.)
- Setting resolution : 0.1A
- Amperage display : 0.0~55.0A
- Display accuracy : 5% FS (when sine wave is 50Hz)
- Minimum time for action confirmation : On time:500 msec.
- Alarm holding : Selectable between Lock (holding) and Real (not holding)
- Sampling cycle : 2 sec.
- Isolation : Insulated between CT input and control output (not isolated between CT input and system and other inputs)

Set value Bias (option)

In SR71, this function can be added unless it has a Heater Break Alarm option.

- Setting range : -1999~2000 unit
- Setting resolution : Same as display resolution
- Action input : Non-voltage contact (bias in action when SB terminal is closed)
- Isolation : Insulated between the SV bias input and the control output (not isolated between the SV bias and the system and other input)

Others

- Data storage : By non-volatile memory (EEPROM)
- Operating ambient temperature : -10~50°C/90% RH max. (no dew condensation)
- /humidity range
- Supply voltage : 100-240V AC±10% (50/60 Hz)
- Power consumption : Approx. 11VA
- Applicable standard Safety : IEC1010-1 and EN61010-1
EMC : EN61326
- Insulation resistance : Between input/output terminal and power supply terminal:
500V DC 20MΩ minimum
Between input/output terminal and protective conductor terminal:
500V DC 20MΩ minimum
- Dielectric strength : 1 min. at 2300V AC between input/output terminal and power supply terminal
1 min. at 1500V AC between power supply terminal and protective conductor terminal
- Protective structure : Only front panel has simple dust-proof and drip-proof structure
- Material : PPO resin molding (equivalent to UL94V-1)
- External dimensions SR71 : H48×W48×D110 (panel depth:100) mm
SR72 : H72×W72×D110 (panel depth:100) mm
SR73 : H96×W96×D110 (panel depth:100) mm
SR74 : H96×W48×D110 (panel depth:100) mm
- Mounting : Push-in panel (one-touch mount)
- Panel thickness : 1.0~3.5 mm
- Panel cutout SR71 : H45×W45 mm, SR72: H68×W68 mm
SR73 : H92×W92 mm, SR74: H92×W45 mm
- Weight SR71 : Approx.180g, SR72: Approx.260g
SR73 : Approx.330g, SR74: Approx.250g

The contents of this manual are subject to change without notice.

Temperature and Humidity Control Specialists **SHIMADEN CO., LTD.**

Head Office: 2-30-10 Kitamachi, Nerima-Ku, Tokyo 179-0081 Japan
Phone: +81-3-3931-7891 Fax: +81-3-3931-3089
E-MAIL: exp-dept@shimaden.co.jp URL: <http://www.shimaden.co.jp>

T 0012200
PRINTED IN JAPAN